

# TRONICALTUNE PLUS

## Template Types

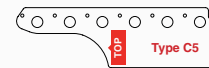

There are different templates available for this Headstock – check which one fits your guitar following the guide below:

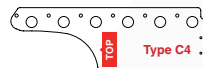
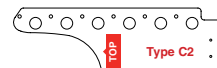
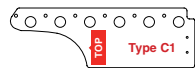
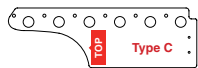

### 1. Printer Settings:

- Size Setting: 100%
- Page Adaption: None
- Page Scaling: None



### 2. Place a ruler onto the printed templates to **check correct printout size**

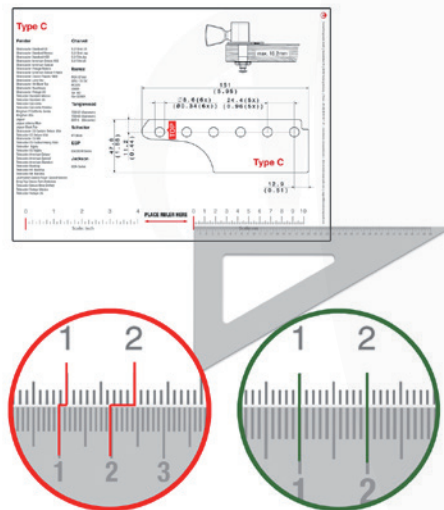

### 3. Cut-out the templates

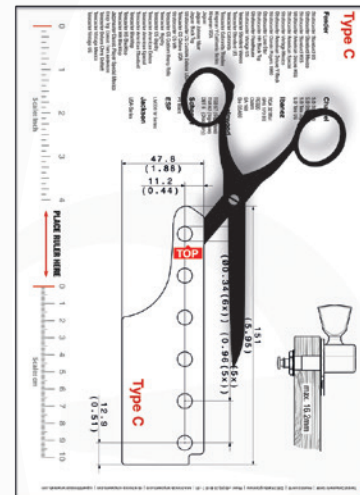

### 4. Place the templates **on the back** of your guitar headstock. Check if the holes of the template are congruent to the holes of your guitar. When they are congruent you identified the template that fits your guitar. Enter this type during the order process.

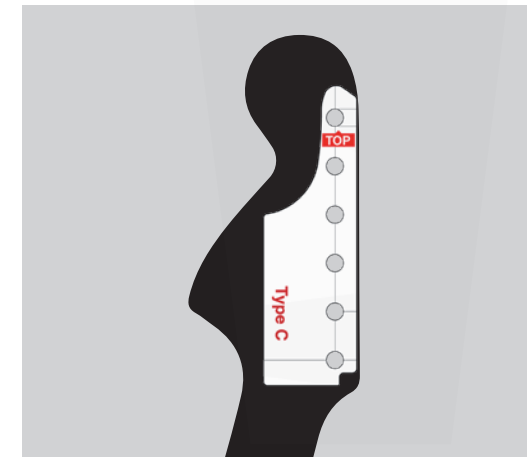

# Type C1

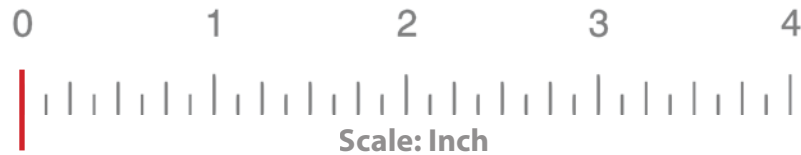
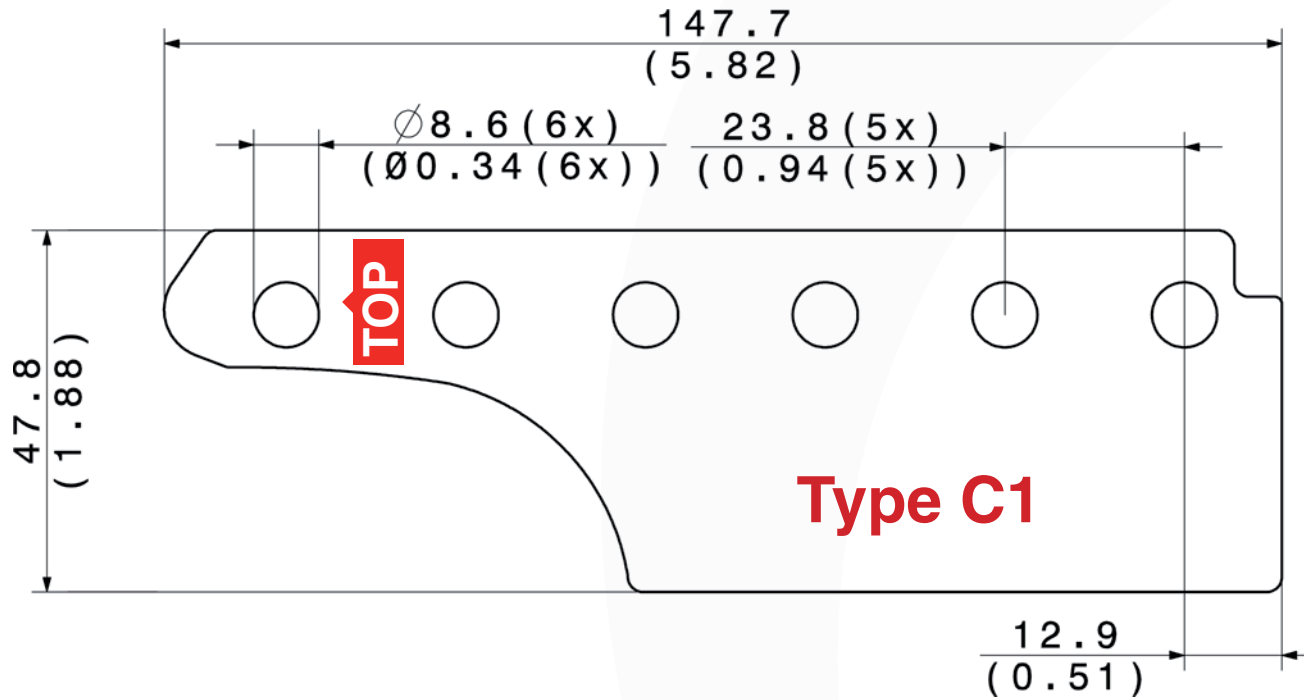
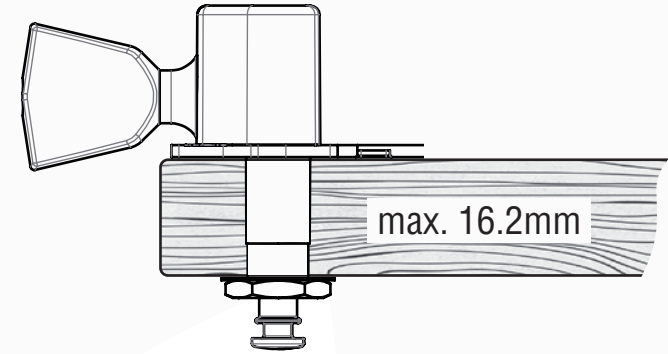

**PLACE RULER HERE**

